

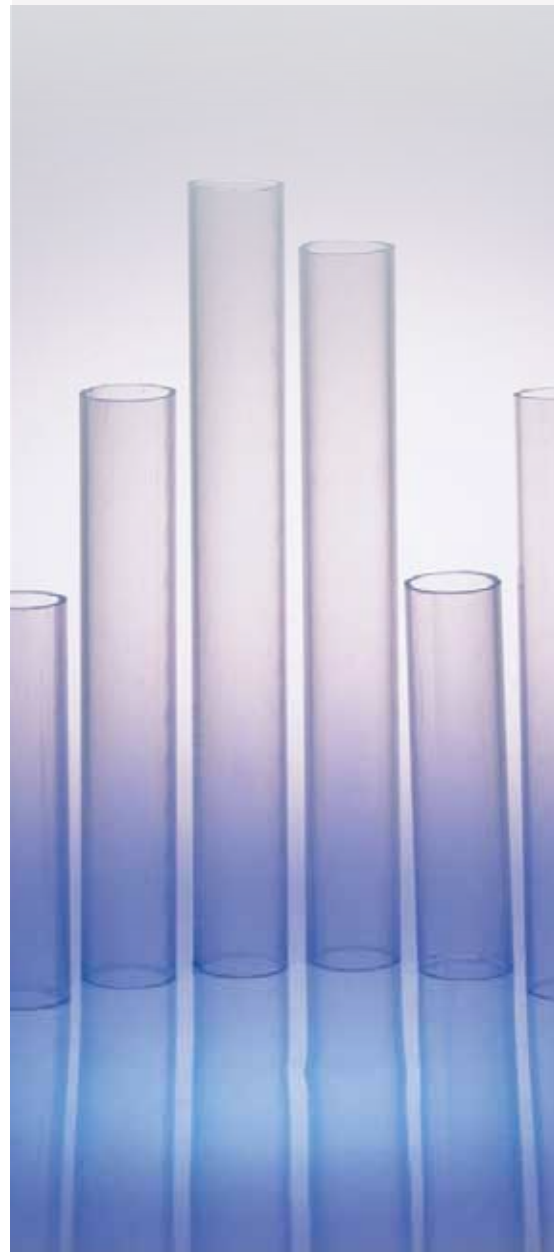

PVC透明管路系統

Clear PVC Piping System



SCH40 CLEAR PVC SYSTEM

Clear PVC 透明管路系統

1. 系統描述

- 環琪塑膠透明PVC管及接頭擁有耐腐蝕、易於安裝及透明度良好之特性。
- 透明管路系統被用來設計於雙套管之應用，提供人員及相關設備保護免於意外傷害。
- 環琪塑膠透明PVC管路系統需確認安裝的環境及溫度，不可安裝在日照直接曝曬環境。特別注意在運送過程中透明管需要給予適當覆蓋，避免因陽光直射而造成透明管曲翹情形發生。
- 環琪塑膠透明PVC管提供尺寸從1/2” ~12” 透明接頭提供從1/2” ~4” SCH 40之規格。
(6” ~12” PVC透明管則依據環琪公司標準製造。)
- 透明PVC管標準長度是3M，若有非標準產品需求需視訂單數量及要求而定。
- 較小口徑之透明PVC配件從1/2” ~4” 是射出一體成型，依據SCH 40 or SCH 80規範生產，較大口徑配件6” ~12” 則由透明PVC管手工製作或者是直接用非透明PVC管件直接取代。

1.1 產品優勢

- 極好的透明度。
- 能用在酸鹼管路或雙套管路之內外管，據有監視及保護作用。
- 化學穩定性高，耐腐蝕。
- 質輕，搬運容易，省工資。
- 管與接頭以冷膠接合，速度快且安全可靠，不需要特殊工具及專業人才。
- 內徑光滑，可以減少水垢及污塞，可減少管摩擦損失。
- 絕緣不導電

1.2 產品特性表

物理特性 Physical Properties	公制單位 Metric units	英制單位 Imperial units	測試條件 Test Condition	標準 Standard
比重 Specific Gravity	1.35~1.40		23°C	ASTM D792
維卡溫度 Softening Temp (Vicat)	67°C	153°F	Loading 50N	ASTM D1525
熱軟化溫度 Heat Deflection Temp.	63°C	145°F	264psi, Annealed	ASTM D790
抗拉係數 Modulus of Elasticity in Tension	2,830N/mm ²	425,000psi	23°C, 5mm/min	ASTM D638
張力強度 Tensile Strength	54.3N/mm ²	7880psi	23°C, 5mm/min	ASTM D638
延伸率 Elongation	92%		23°C, 5mm/min	ASTM D638
艾氏衝擊強度 Izod Impact (Notched)	31J/m	0.59ft-lb/in	10mm/0.5kg	ASTM D256
最高操作溫度 Max Service Temp.	50°C	122°F	-	-
燃燒性 Flammability	V0			UL-94

備註：以上資料僅供參考

1.3 嚴格品質及製造規範

- ASTM D256 是規範塑膠材料艾氏衝擊強度測試方法
- ASTM D638 是規範塑膠材料拉伸特性測試方法
- ASTM D1525 是規範塑膠材料維卡軟化溫度測試方法
- ASTM D1784 硬質聚氯乙烯化合物和氯化聚乙烯化合物的標準規範
- UL 94 是規範設備和器材塑膠材料配件耐燃測試標準

2. 設計參考資料

2.1 Clear PVC Pipe 透明管壓力等級 - PVC 2110

尺寸 Size	最大工作水壓 Max. Working Pressure	
	Kgf/cm ²	psi
1/2"	21.2	300
3/4"	16.9	240
1"	15.5	220
1-1/4"	12.7	180
1-1/2"	12.0	170
2"	9.9	140
2-1/2"	10.6	150
3"	9.2	130
4"	7.7	110
6"	6.3	90
8"	5.6	80
10"	4.9	70
12"	4.5	65

2.2 溫度遞減常數- Clear PVC Pipe

工作溫度 Working Temperature		遞減常數 Derating factor
°F	°C	
73	23	1.00
80	27	0.88
90	32	0.75
100	38	0.62
110	43	0.51
120	49	0.40

3. 產品規格

3.1 SCH 40 Clear PVC Pipe 管

Size	Standard			
	D	Tolerance	t(min)	Tolerance
1/2"	21.34	±0.10	2.77	+0.51
3/4"	26.67	±0.10	2.87	+0.51
1"	33.40	±0.13	3.38	+0.51
1-1/4"	42.16	±0.13	3.56	+0.51
1-1/2"	48.26	±0.15	3.68	+0.51
2"	60.32	±0.15	3.91	+0.51
2-1/2"	73.02	±0.18	5.16	+0.61
3"	88.90	±0.20	5.49	+0.66
4"	114.30	±0.23	6.02	+0.71
* 6"	168.28	±0.28	7.00	+1.00
* 8"	219.08	±0.38	7.00	+1.00
* 10"	273.05	±0.38	8.00	+1.50
* 12"	323.85	±0.38	8.00	+1.50

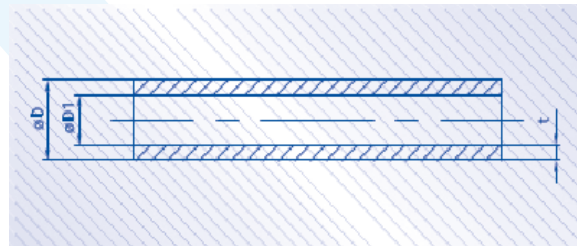

備註：假如有註記“*”則表示該項沒有符合ASTM標準。(單位：mm)

3.2 SCH 80 Clear PVC 90° Elbow 彎頭 (Slip × Slip)

Size	Outside Dia	Socket Type			Structure Diameter	
	D0	d1	d2	I	d	G
1/2"	31.5	21.54	21.23	22.22	16.50	12.80
3/4"	37.3	26.87	26.57	25.40	22.00	15.30
1"	45.9	33.65	33.27	28.58	28.00	18.00
1-1/4"	55.2	42.42	42.04	31.75	35.00	23.00
1-1/2"	62.4	48.56	48.11	34.93	43.00	26.00
2"	74.9	60.63	60.17	38.10	54.00	32.00
2-1/2"	90.0	73.38	72.85	44.45	69.00	38.00
3"	107.0	89.31	88.70	47.63	84.00	48.00
4"	133.0	114.76	114.07	57.15	105.00	59.00

(單位：mm)

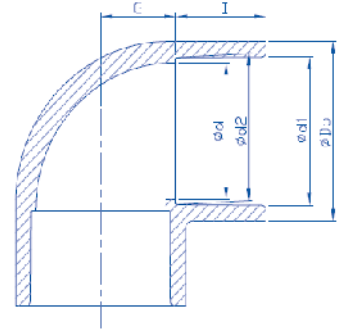

3.3 SCH 80 Clear PVC 45° Elbow 彎頭 (Slip × Slip)

Size	Outside Dia	Socket Type			Structure Diameter	
	D0	d1	d2	I	d	L
1/2"	30.8	21.54	21.23	22.22	16.50	6.50
3/4"	39.1	26.87	26.57	25.40	22.00	8.00
1"	45.8	33.65	33.27	28.58	28.00	8.00
1-1/4"	55.8	42.42	42.04	31.75	35.00	10.00
1-1/2"	62.3	48.56	48.11	34.93	43.00	12.00
2"	75.5	60.63	60.17	38.10	54.00	16.00
2-1/2"	90.0	73.38	72.85	44.45	69.00	18.00
3"	107.0	89.31	88.70	47.63	84.00	20.00
4"	133.0	114.76	114.07	57.15	108.00	26.00

(單位：mm)

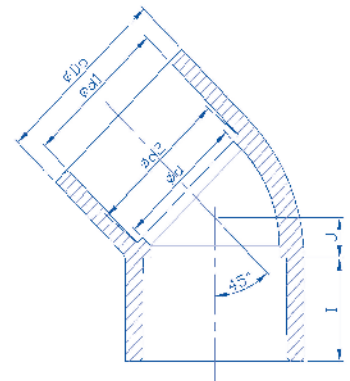

3.4 SCH 80 Clear PVC Coupling 直接頭 (Slip × Slip)

Size	Outside Dia	Socket Type			Structure Diameter	
	D0	d1	d2	I	d	L
1/2"	30.5	21.54	21.23	22.22	16.50	52.00
3/4"	37.6	26.87	26.57	25.40	22.00	60.00
1"	46.2	33.65	33.27	28.58	28.00	65.00
1-1/4"	55.2	42.42	42.04	31.75	35.00	75.00
1-1/2"	60.9	48.56	48.11	34.93	42.50	79.50
2"	73.4	60.63	60.17	38.10	54.00	88.00
2-1/2"	89.0	73.38	72.85	44.45	65.00	100.00
3"	106.0	89.31	88.70	47.63	80.00	108.00
4"	133.0	114.76	114.07	57.15	100.00	126.00

(單位：mm)

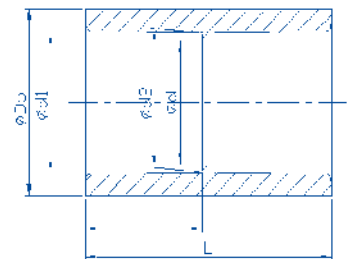

3.5 SCH 80 Clear PVC Tee 三通 (Slip × Slip × Slip)

Size	Outside Dia	Socket Type			Structure Diameter		
	D0	d1	d2	I	d	L	H
1/2"	30.2	21.54	21.23	22.22	16.50	72.30	37.25
3/4"	37.4	26.87	26.57	25.40	24.00	89.10	42.50
1"	45.7	33.65	33.27	28.58	28.00	102.60	51.50
1-1/4"	55.8	42.42	42.04	31.75	35.00	119.00	57.75
1-1/2"	62.3	48.56	48.11	34.93	41.00	132.00	64.00
2"	75.2	60.63	60.17	38.10	52.00	151.90	73.00
2-1/2"	92.0	73.38	72.85	44.45	69.00	173.00	86.50
3"	109.0	89.31	88.70	47.63	84.00	197.00	98.50
4"	135.0	114.76	114.07	57.15	109.0	239.00	119.50

(單位：mm)

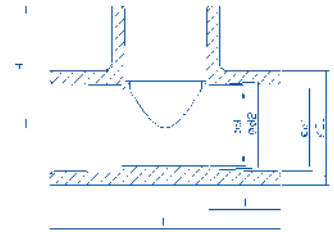

3.6 SCH 40 Clear PVC 90° Elbow 彎頭 (Slip × Slip)

Size	Outside Dia	Socket Type			Structure Diameter	
	D0	d1	d2	I	d	G
1/2"	27.5	21.54	21.23	17.80	18.00	12.70
3/4"	33.6	26.87	26.57	22.20	22.50	14.80
1"	41.4	33.65	33.27	26.10	29.00	18.30
1-1/4"	50.5	42.42	42.04	27.70	38.00	22.70
1-1/2"	56.8	48.56	48.11	28.30	43.50	25.70
2"	69.0	60.63	60.17	30.00	55.00	32.00
2-1/2"	84.2	73.38	72.85	45.00	67.50	39.00
3"	100.8	89.31	88.70	48.10	83.50	46.50
4"	127.3	114.76	114.07	51.30	108.50	59.70

(單位：mm)

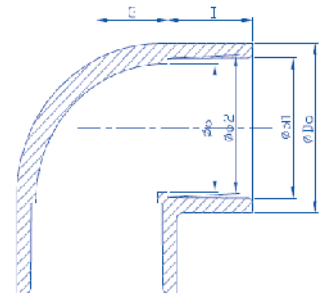

3.7 SCH 40 Clear PVC 45° Elbow 彎頭 (Slip × Slip)

Size	Outside Dia	Socket Type			Structure Diameter	
	D0	d1	d2	I	d	L
1/2"	27.5	21.54	21.23	17.80	18.00	6.40
3/4"	33.1	26.87	26.57	18.70	22.50	8.00
1"	40.9	33.65	33.27	22.70	29.00	8.00
1-1/4"	50.1	42.42	42.04	24.30	38.00	9.60
1-1/2"	56.5	48.56	48.11	28.30	43.50	11.20
2"	69.0	60.63	60.17	29.90	55.00	16.00
2-1/2"	84.2	73.38	72.85	45.00	67.50	18.00
3"	100.8	89.31	88.70	48.10	83.50	20.00
4"	127.3	114.76	114.07	51.30	108.50	25.40

(單位：mm)

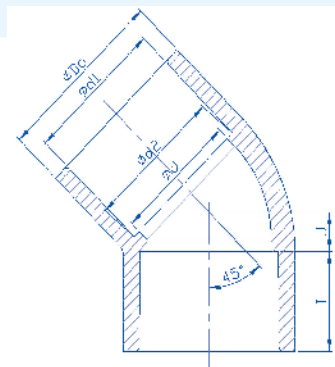

3.8 SCH 40 Clear PVC Coupling 直接頭 (Slip × Slip)

Size	Outside Dia	Socket Type			Structure Diameter	
	D0	d1	d2	I	d	L
1/2"	27.5	21.54	21.23	17.80	18.00	38.60
3/4"	33.5	26.87	26.57	18.70	22.50	47.50
1"	41.7	33.65	33.27	22.70	29.00	50.70
1-1/4"	50.5	42.42	42.04	24.30	38.00	58.10
1-1/2"	56.8	48.56	48.11	28.30	43.50	60.00
2"	69.0	60.63	60.17	29.90	55.50	63.30
2-1/2"	84.2	73.38	72.85	45.00	67.50	95.00
3"	100.8	89.31	88.70	48.10	83.50	101.20
4"	127.3	114.76	114.07	51.30	108.50	107.60

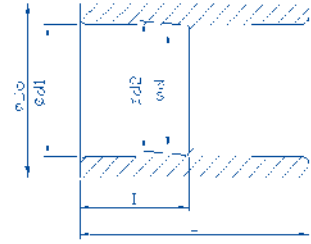

(單位：mm)

3.9 SCH 40 - Tee 三通 (Slip × Slip × Slip)

Size	Outside Dia	Socket Type			Structure Diameter		
	D0	d1	d2	I	d	L	H
1/2"	27.5	21.54	21.23	17.80	18.00	61.00	30.50
3/4"	33.6	26.87	26.57	18.70	22.50	67.00	33.50
1"	41.7	33.65	33.27	22.70	29.00	82.00	41.00
1-1/4"	50.5	42.42	42.04	24.30	38.00	94.00	47.00
1-1/2"	56.8	48.56	48.11	28.30	43.50	108.00	54.00
2"	69.0	60.63	60.17	29.90	55.00	124.00	62.00
2-1/2"	84.2	73.38	72.85	45.00	67.50	168.00	84.00
3"	100.8	89.31	88.70	48.10	83.50	189.20	94.60
4"	127.3	114.76	114.07	51.30	108.50	222.00	111.00

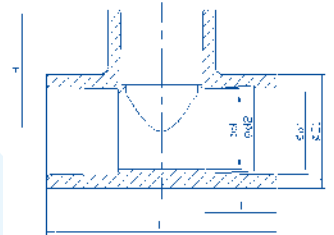

(單位：mm)



CPVC Advanced
Industrial Piping System
CPVC先進工業管路系統



Thermoplastic Valves
塑膠閥門(凡而)



UPVC Industrial Piping System
UPVC工業管路系統



CPVC High Performance
Fire Sprinkler System
CPVC高效能消防管路系統



PVC-M1 Cable Tray
防火耐燃電纜線槽

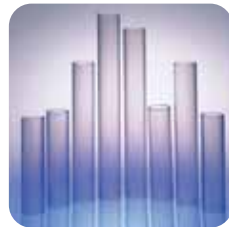

Clear PVC Piping System
PVC透明管路系統



CPVC/HT-PVC Sheet
CPVC / HT-PVC板材



CPVC Hot & Cold water
Distribution System
CPVC 冷熱水管路系統



鑽琪塑膠股份有限公司
Hershey Valve Co., Ltd.

43541 台中市梧棲區中港加工出口區經二路16號
No.16, Jing 2nd Rd., Wuchi, Taichung,
ChungKang Export Processing Zone, 43541 Taiwan, R.O.C.
Tel : +886-4-2659 5377 Fax : +886-4-2659 5288
Http : //www.hershey.com.tw
E-mail : info@hershey.com.tw

